

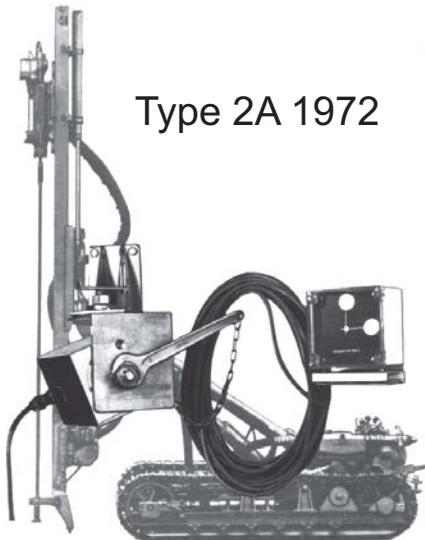

TRANSTRONIC

HIGH PRECISION INSTRUMENTS FOR ROCK DRILLING



Type 2A 1972

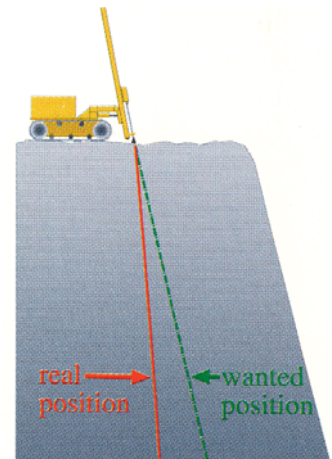

Example of Deviation error

1 Deg	1,8 cm/meter
2 Deg	3,5 cm/meter
3 Deg	5,2 cm/meter
4 Deg	7,0 cm/meter

Founded in 1972 and located in Köping
150 km west of Stockholm, Sweden

Manufacturer of:

Angle indicators and hole length measurement instruments

GPS-navigation and GPS-compasses

Hole deviation measurement, scanning and GPS-surveying

Data recording and logging instruments

Transducers for heavy environments.



TRANSTRONIC

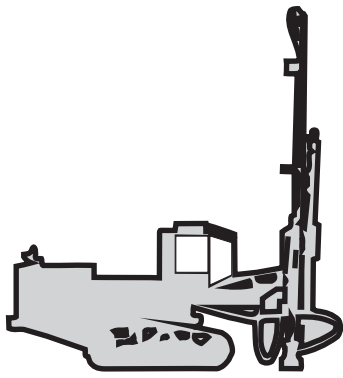

Inklinator 2V2
Vertical Angle measurement

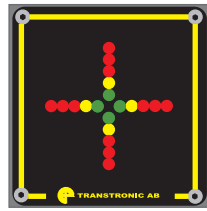

Inklinator 2P
Angle measurement
Non Cab rig



Inklinator CMD
Angle or Length measurement



Inklinator CMI Bench
Angle, Length measurement
with laser



Inklinator GPS COMPASS



Inklinator GPS Level system
for CMI and CMS Bench



Inklinator CMS
Instrument in PC environment
Angle and Length measurement with laser/GPS
Logging and monitoring function.

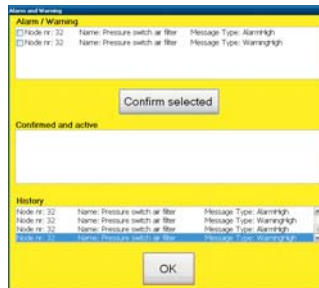

Alarm/warning menu:
Alarm/warning list,
active/confirmed/history

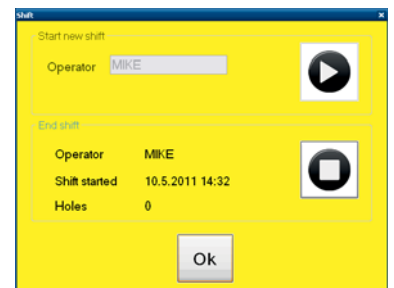

Shift start/stop menu:
Start and stop of shift logging

Inklinator CPN
Navigation system with:
Angle and Length measurement
GPS navigation and GPS compass



**Inklinator CMI Tunneling
Horizontal+ Vertical
angle measurement**

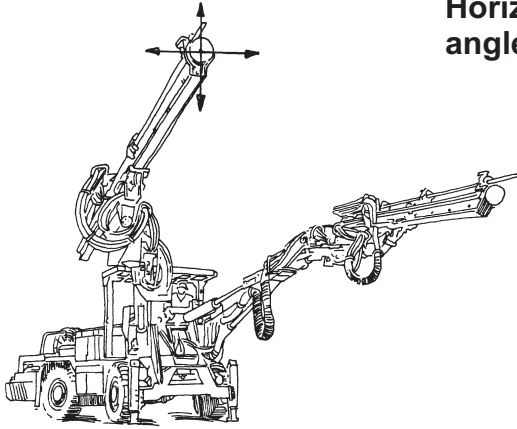

**Inklinator CMI Production
Angle+ Length measurement**

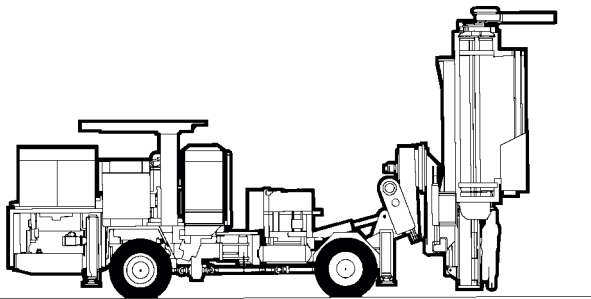

**Inklinator CMI Production moving boom
Angle measurement**

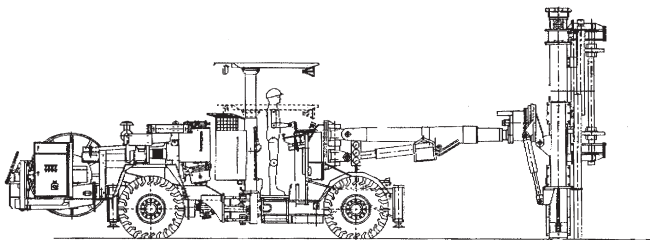

**Inklinator CMS for tunnel and production rigs.
Instrument in PC environment.
Angle and Length measurement.
Logging and monitoring function.**

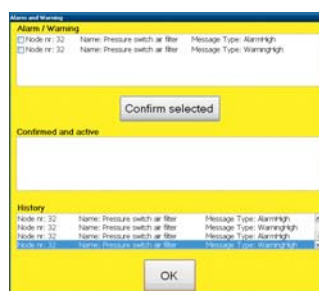

Alarm/warning menu:
Alarm/warning list,
active/confirmed/history

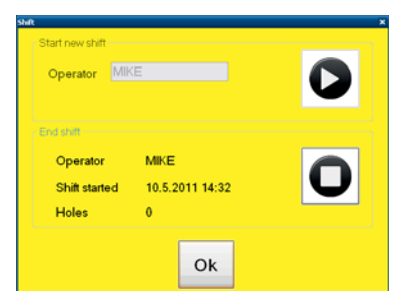

Shift start/stop menu:
Start and stop of shift logging

Blast design and hole deviation system: Scanning, Surveying and Measuring

Scan the rockface

Make a drill pattern and set out the collaring points/export through IREDES

Drill the holes.

Survey the holes.

Measure the hole deviation.

Analyze the result in 3D-software

